

REV.	ENCL. NO.	APPD.
A	HC961853	I. K. LIU for 11/30/96
B	HC981106	I. K. LIU 5/22/98
C	HC990219	Dick Lee 1/18/99
D	HC992748	Dick Lee 9/12/99
E	IC022083	Yhsin Chen 6/3/02

NOTE: UNLESS OTHERWISE SPECIFIED
 1. DIMENSION SHALL BE INTERPRETED PER ANSI Y14.5M-1994
 2. PROD. SPEC ARE SHOWN ON DRAWING 307-0300-137
 3. MATERIAL OF $\text{\textcircled{1}}$ AND $\text{\textcircled{2}}$ ARE SHOWN ON DRAWING 307-0000-812
 PART NO.: HF11***-□□□

OPTIONAL FOR MODIFICATION CODE
 NONE: NO GUIDE POST, DIM. D=3.30[.130]
 P1: ONE GUIDE POST, DIM. D=3.30[.130]
 C1: ONE GUIDE POST, DIM. D=2.30[.091]

NONE : HOUSING COLOR BLACK
 N : HOUSING COLOR IVORY
 G : HOUSING COLOR GREEN
 U : HOUSING COLOR BLUE
 Y : HOUSING COLOR YELLOW

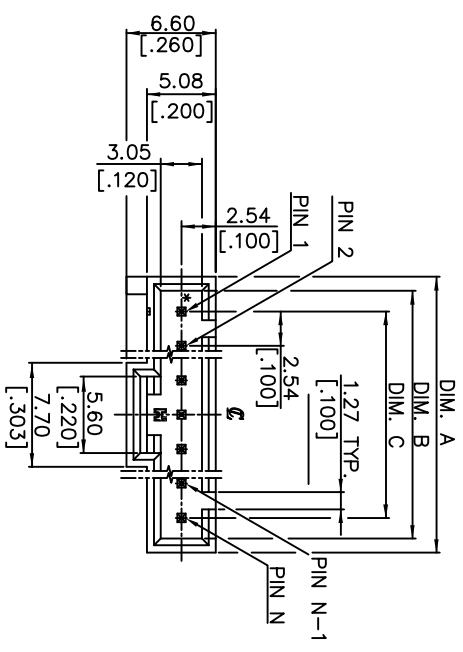

TYPE III

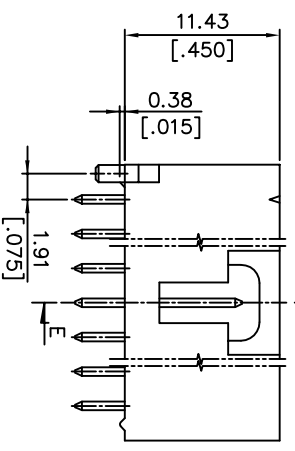

P/N: HF11NNN-P1

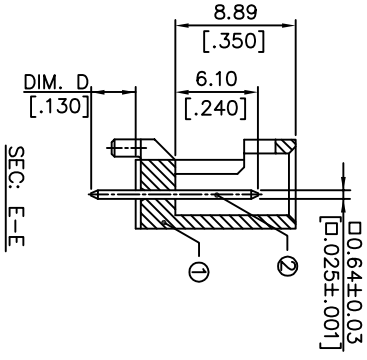

SEC. E-E

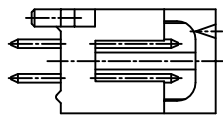

TYPE I

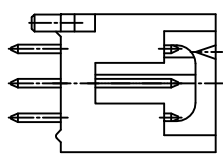

TYPE II

SAME AS TYPE III EXCEPT AS SHOWN

SAME AS TYPE III EXCEPT AS SHOWN

PART NO.	DIM. A	DIM. B	DIM. C	TYPE
HF1100-□□□	27.99 [1.102]	25.91 [1.020]	22.86 [900]	III
HF11090-□□□	25.45 [1.002]	23.37 [920]	20.32 [800]	III
HF11080-□□□	22.91 [902]	20.83 [820]	17.78 [700]	III
HF11060-□□□	17.83 [702]	15.75 [620]	12.70 [500]	III
HF11050-□□□	15.29 [602]	13.21 [520]	10.16 [400]	III
HF11040-□□□	12.75 [502]	10.67 [420]	7.62 [300]	III
HF11030-□□□	10.21 [402]	8.13 [320]	5.08 [200]	II
HF11020-□□□	7.62 [300]	5.55 [219]	2.54 [100]	I

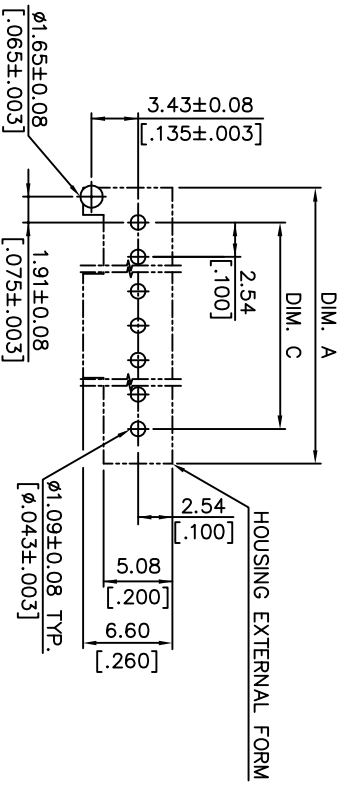

HOUSING EXTERNAL FORM

RECOMMENDED P.C.B. LAYOUT

UNITS	FINISH	QTY
M/M [INCH]		
X±	X²±	
X± 0.38	X²±	
.XX± 0.25	.XX²±	
.XXX±	.XXX²±	

THESE DRAWINGS AND SPECIFICATIONS ARE THE PROPERTY OF HON HAI PRECISION IND. CO., LTD. AND SHALL NOT BE REPRODUCED, COPIED, OR USED IN ANY MANNER WITHOUT THE WRITTEN PERMISSION OF HON HAI PRECISION IND. CO., LTD.

APPD: I. K. LIU for 11/30/96
 CHKD: PAI NOV/29/96
 DR: Y. S. HSIAO 11/25/96

DWG NO.: 307-0000-284

SCALE SHEET REV.
 N/A 1/2 E

FOXCONN
 HON HAI PRECISION IND. CO.,LTD.
 TAIPEI, TAIWAN, R.O.C.

TITLE: CUSTOMER DRAWING

REV.	ECN.	NO.	APPD.

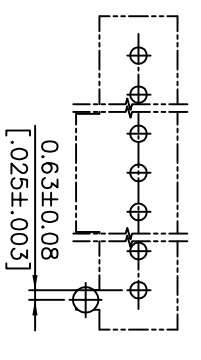
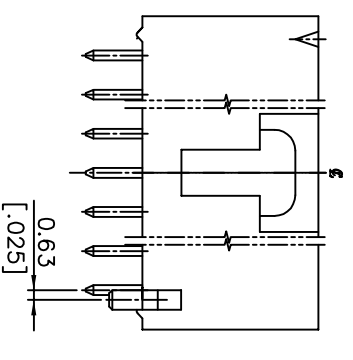
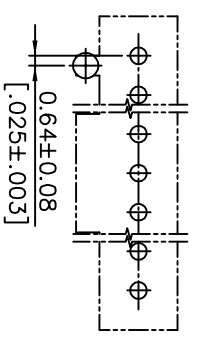
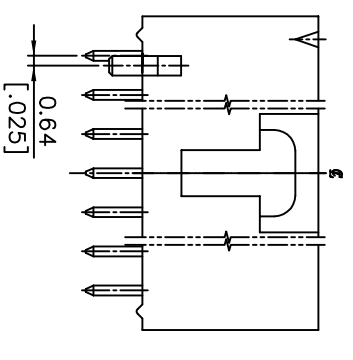
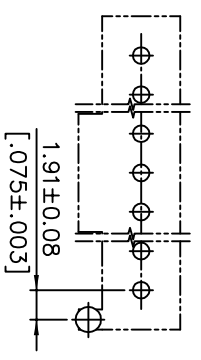
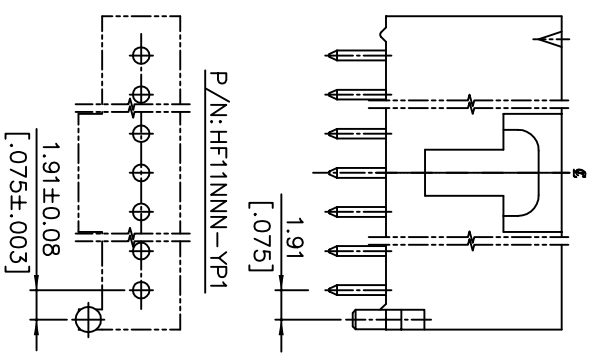
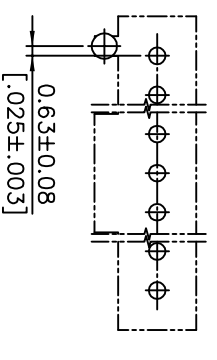
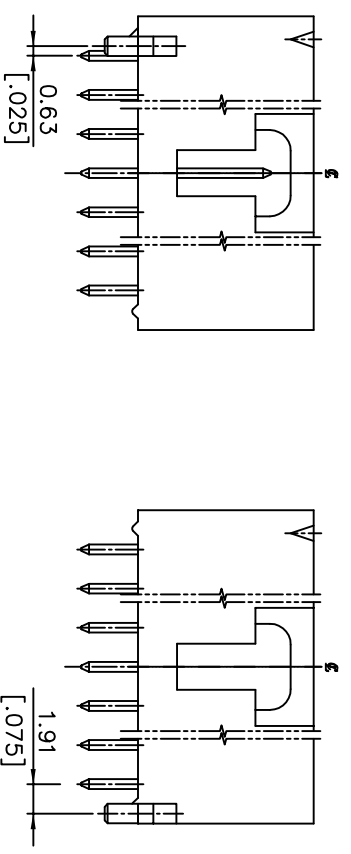

X±	X²±	UNITS	mm
.X±	.X²±	MAT'L	
.XX±	.XX²±	FINISH	
XXX±	XXX²±		

THESE DRAWINGS AND SPECIFICATIONS ARE THE PROPERTY OF HON HAI PRECISION IND. CO., LTD. AND SHALL NOT BE REPRODUCED OR TRANSMITTED IN ANY FORM OR BY ANY MEANS, ELECTRONIC OR MECHANICAL, INCLUDING PHOTOCOPYING, RECORDING, OR BY ANY INFORMATION STORAGE AND RETRIEVAL SYSTEM, WITHOUT THE PRIOR WRITTEN CONSENT OF HON HAI PRECISION IND. CO., LTD.

NAME (INTENDED USE)	SINGLE ROW, 120° POCKET S/T HEADER	FOXCORN HON HAI PRECISION IND. CO., LTD. TAIPEI, TAIWAN, R.O.C.
PART NO. (INTENDED USE)	HF11 SERIES	
TITLE:	CUSTOMER DRAWING HEADER	
APPD:	Dick Lee 1/18/99	DWG NO.:
CHKD:		307-0000-284
DR:	Y. S. HSIAO, 1/15/99	

SCALE SHEET	REV.
N/A	2/2
E	E